

# Water Cooled Protection House

## *ODS Red-Line Models.*

This house is made of Stainless Steel and is primarily intended for water cooling, but compressed air with vortex cooler can alternatively be used.

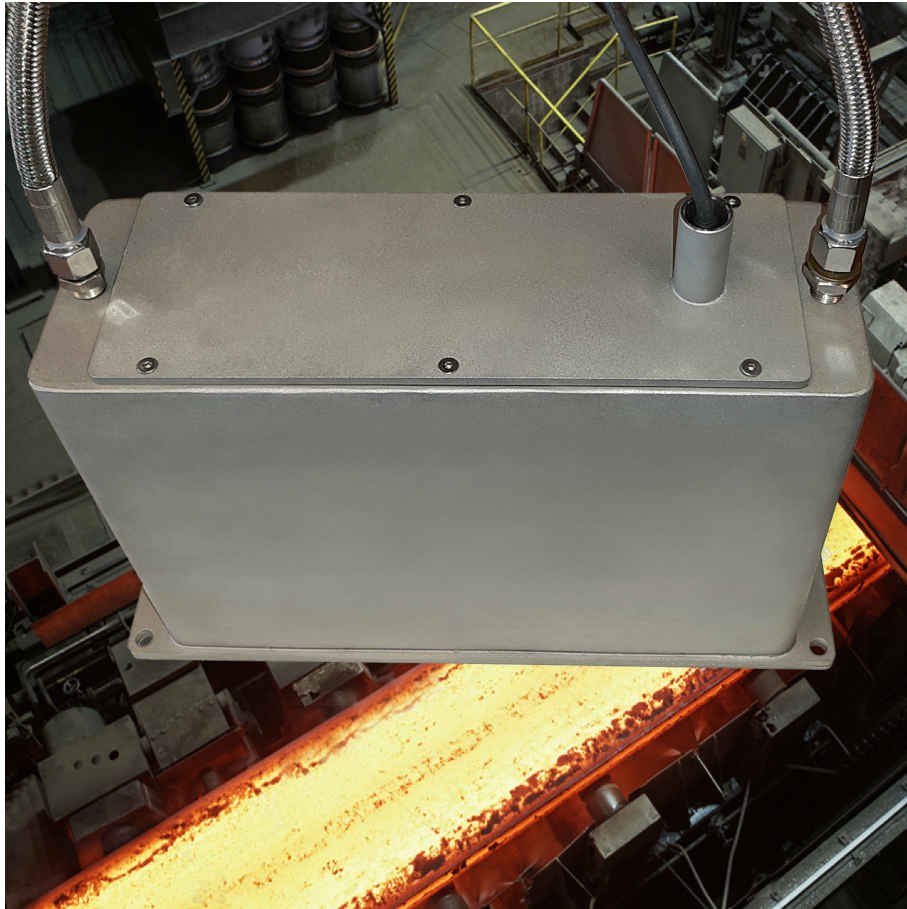

The house is built with double walls on 5 of the 6 sides in order to have the sensor fully enclosed by water except at the back side. A sealed back plate allows for the sensor to fit snugly in the sealed enclosure. Please see the dimensions and data on the next page.

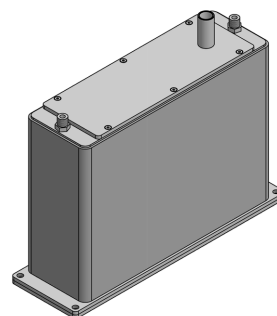
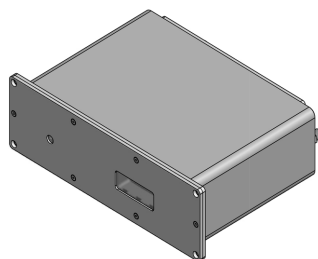

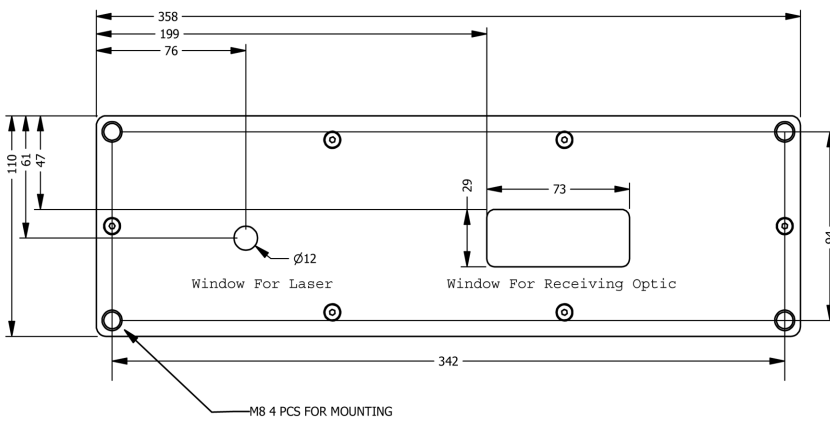
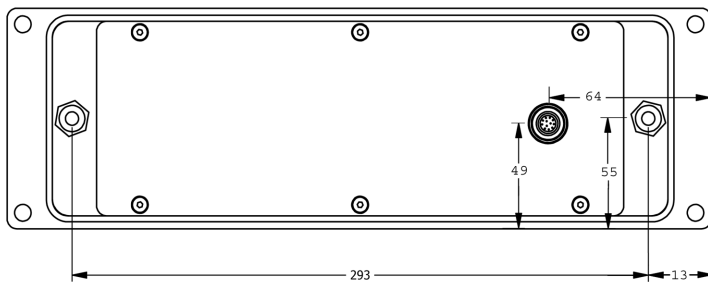
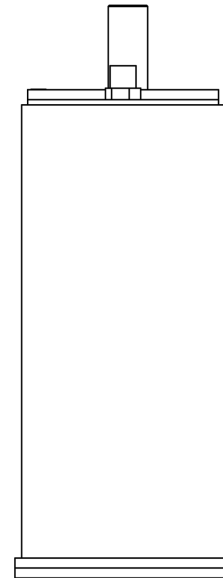
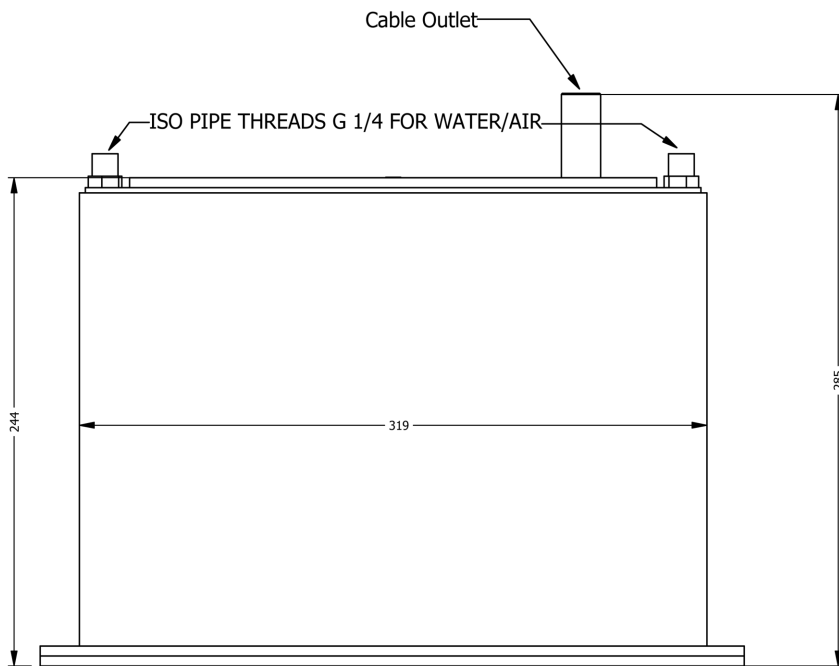

### Data:

**Connection:** ISO PIPE THREADS G 1/4.

**Flow Direction:** Both directions.

**Recommended Water Flow:** 1-5 litre per minute.

**Max Pressure:** 2 bar.

**Weight:** 14 Kg.